

# One Sky

ALUMINUM · STAINLESS · GLASS

铝材 · 不锈钢 · 玻璃

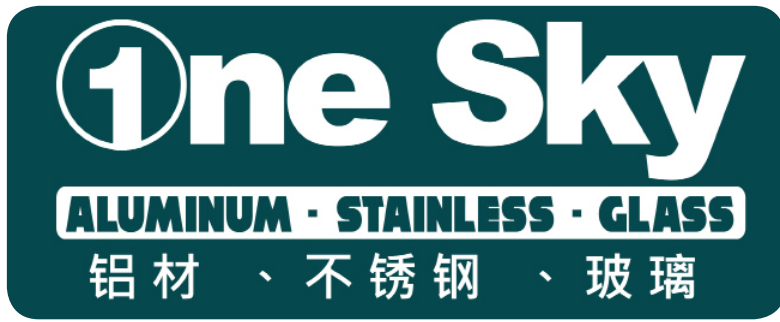



## VISION

After years of cultivation, we will strive to be the best service driven, most credible, best quality & fair price, aluminum supplier that will make us become top enterprises in aluminum industry.

## MISSION

Our aim is to help aluminum fabricator / contractor enhance their knowledge & skills in aluminum product by bringing in the most advance technology & updated informations from different country, helping local fabricator raise their standards in aluminum.

## CORPORATE VALUES

We will achieve our vision by instilling in all our people the values of integrity, initiative, loyalty, innovation, quality excellence, customer/supplier satisfaction and teamworks with discipline that shall keep us growing.

# ONE SKY ALUMINUM & STAINLESS SUPPLY ENTERPRISE

One sky, established in 2011, continues to thrive today steadfast in its vision of “Supplying Nothing Short of Excellence”. Onesky maintains strong market presence in the Philippines and has quickly gained product dominance in the aluminum industry in a short period of time. The company primarily attributes its rapid progress to it’s unwavering dedication in providing its clientele an improved system of top quality aluminum products.

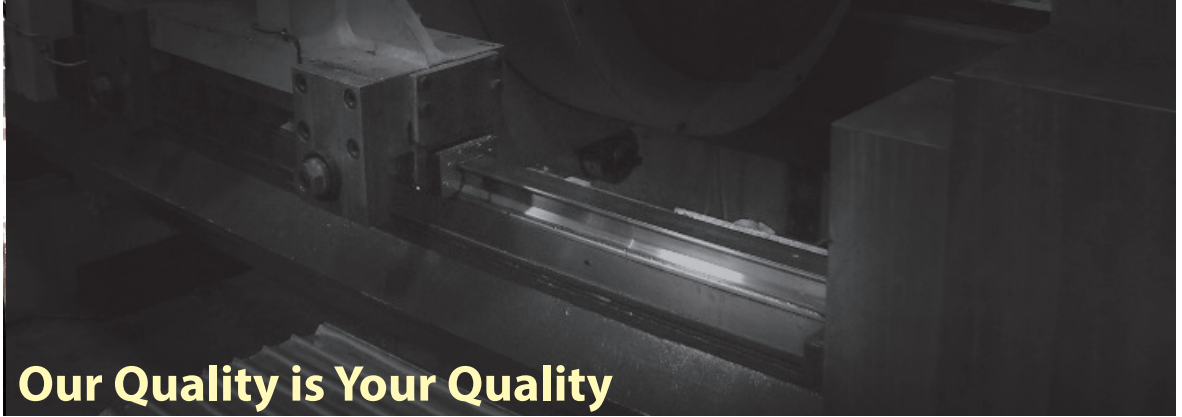

## Our Quality is Your Quality

Over million One sky windows and doors fitted around the philippines is a strong testament to One sky unrivaled leadership in design and quality.

The “little things” make the difference in performance and better service. We pay special attention to details. These details have a direct bearing on quality. From the choice of raw materials, through the extrusion process and all the way to the manufacturing of the windows, strong emphasis is placed on details



**WE DELIVER  
OUR PRODUCTS  
NATIONWIDE.**



- Multi-step elevated high sill design with drainage hole against water leakage.



## **A Quality window must possess following features:**

- Water Proofing > Use Higher Sill**
- Sound insulated > A good glazing / EPDM Rubber Performance**
- Thermal Insulated > Double Glaze Glass**
- Silence in sliding > Quality Sliding Roller**
- Combination of Durable Hardware > Longlasting performance**
- Quality Aluminum Section > Choose Onesky brand (Anti-corrosive & Discoloration)**
- Safety Purposes > Use Tempered Glass**

# One Sky

ALUMINUM · STAINLESS · GLASS

铝材 · 不锈钢 · 玻璃

## ONE SKY POWDER COATING

NEW MORE COLORS!

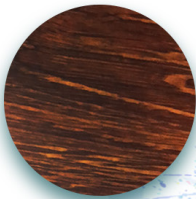

#1001  
WOOD FINISH 1

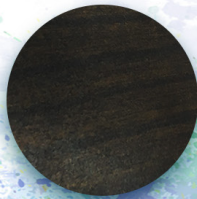

#1002  
WOOD FINISH 2



#1003  
WOOD FINISH 3

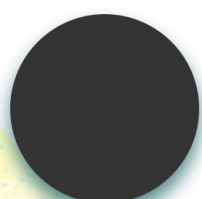

#2001  
MATTE GRAY



#2002  
GLOSSY GRAY



#3001  
BROWN



#4001  
MATTE BLACK



#5001  
WHITE

### FEATURES:

- ✓ Greater coverage area per application
- ✓ Good UV protection
- ✓ Scratch-resistant
- ✓ Resistant to various household chemicals
- ✓ Easy to clean
- ✓ Uniform finish

One Sky is providing a very high level of service, from abrasive blasting, chemical pre-treatment to powder coating of aluminum profiles and doors to a large array of regular commercial and domestic clientele (offering a fast turnaround for urgent orders).

One Sky has excellent future growth potential and all the necessary plant and equipment is in good condition including acid tanks, spray booth, sand blasting bay and large baking oven. A pick up vehicle and forklift along with fully qualified reliable staff are in place, who will remain.

# One Sky

ALUMINUM · STAINLESS · GLASS

铝材 · 不锈钢 · 玻璃

## NEW 798 & 900 3 TRACKS SLIDING SERIES

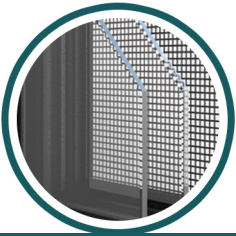
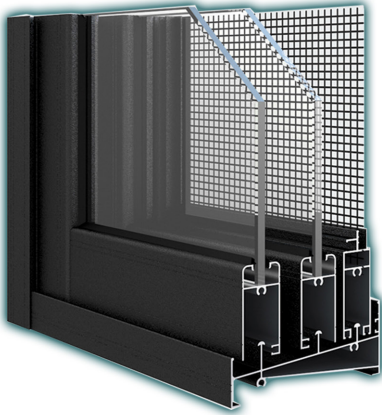

**HARD MESH SCREEN  
FOR LIFE TIME USE**

### ***NEW FEATURES***



**SCREEN EMBEDDED  
IN SLIDING TRACK  
WITH INDIVIDUAL  
ROLLER FOR  
SMOOTHER SLIDE**

One Sky uses aluminum to build windows in order to provide a virtually maintenance-free exterior that can resist the elements. Light yet strong aluminum windows can be created in a wide range of combinations.

The narrowness of the aluminum frame shifts the focus on the glass and subsequently, the view it offers. One Sky provides you with aluminum windows that have baked-on or anodized finishes to make the colors pop and last for a long time.

The mechanically joined and sealed corners of the aluminum windows stay square and true even after years of use.

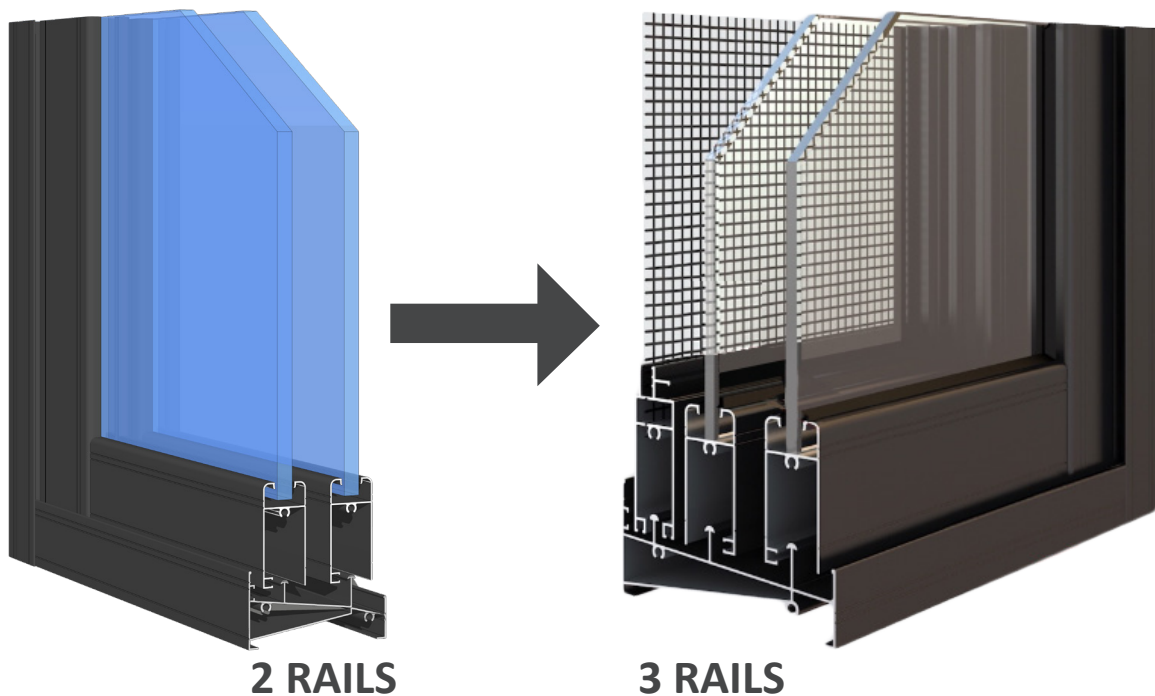

## 798 SERIES (1.0mm)

*Sliding Windows (Classic Series)*

### Characteristics & Advantages

#### Innovative Design

- Multi-step elevated sill design with drainage hole against water leakage.
- Connect with double header, fixed transom without using tubular and snap-on base cover.
- Delicate insect screen easy to install and detach for cleaning and repair purpose
- Top and bottom plastic guides smooth and quite sliding motion.
- Added the sound-insulated dense strip design, to assure perfect sound proofing against sudden impact.
- No use of open back installation.

#### Less Assembly Time

- Use of puncher machine for less time consuming (heavy duty machine, manual process)

#### Price Competitive

- The price is the same compare to old traditional section but with lesser assembly time.

#### Less Inventory

- Top-rail and bottom-rail are the same.
- Double head, sill and jamb is adaptable whether with screen or without screen.
- Only 6 section is needed to fabricate a window.

**10 years warranty** against discoloration of section.

**Stocks** are stable and sufficient.

**798 PROFILE Accessories**

PH Standard 1.0mm thickness



798 blue panel roller single

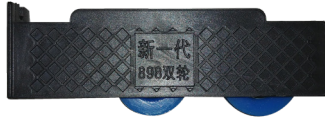

798 blue panel roller double



NEW Autolock



798 panel roller single



798 panel roller w/ bearing



new screen guide top/bottom



908 Center Lock



798 double roller heavy duty



new screen roller



screen guide top/bottom



907 Center Lock



798 jamb rubber



metal screen roller



798 plastic guide 4 kinds



screen bracket



screen vinyl/bundle



top/bottom mohair



Mohair

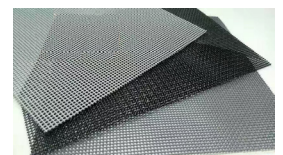

Hardmesh



## 798 PROFILES Sliding Window

PH Standard 1.0mm thickness

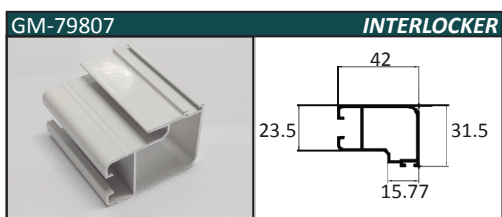
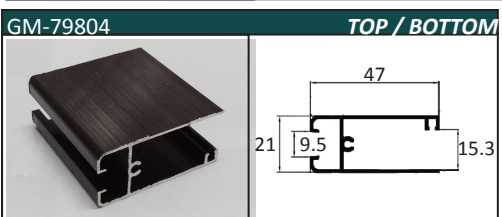
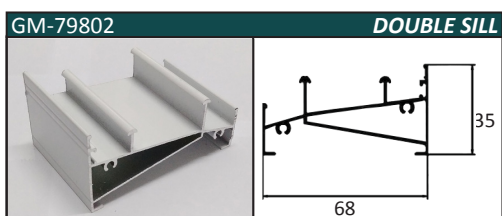
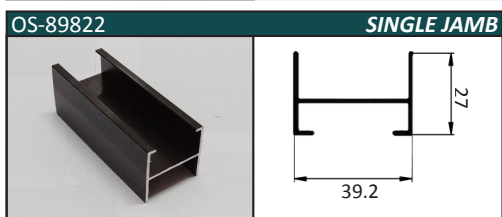
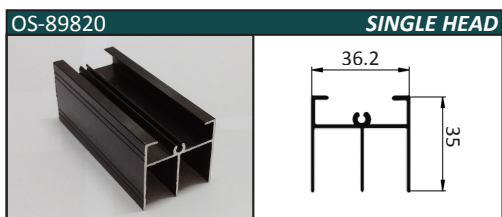
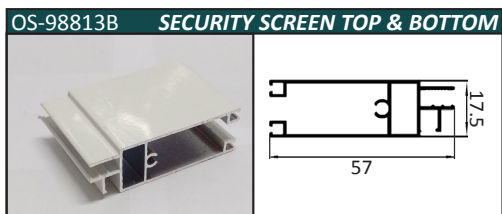
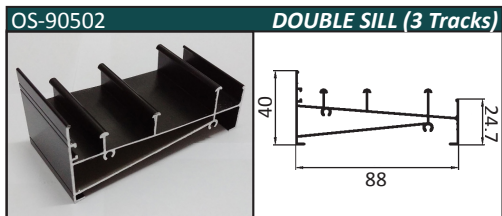
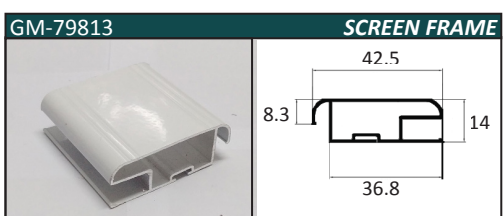
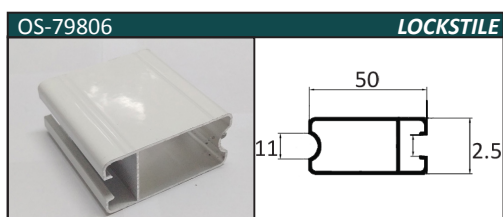
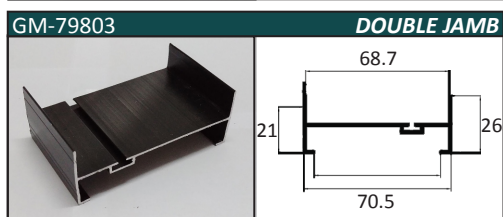
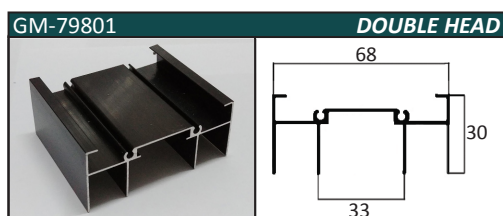
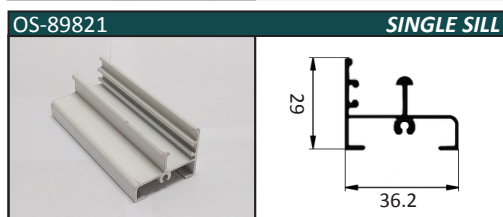
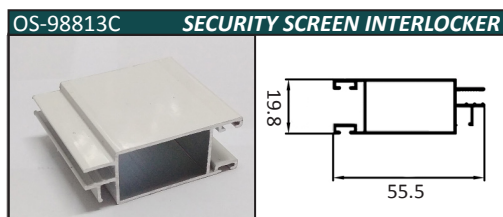
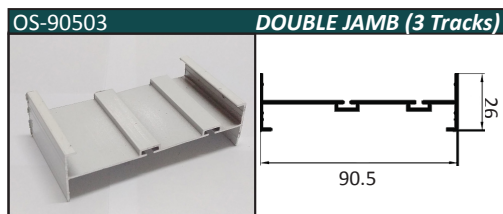
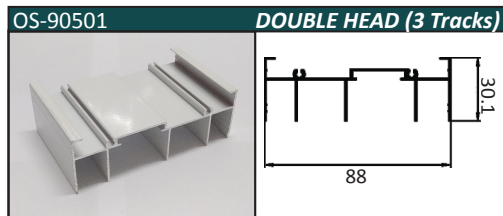

**798 PROFILES Sliding Window**

PH Standard 1.0mm thickness

GM-79810 **FIX HEADER**

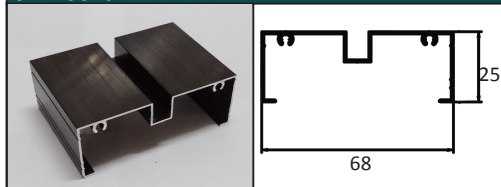

GM-79812 **JAMB MOULDING**

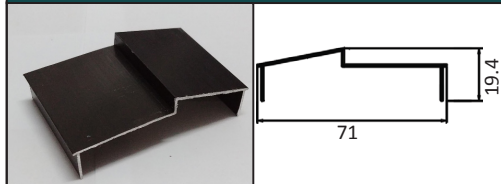

GM-79814 **PANEL ASTRAGAL**

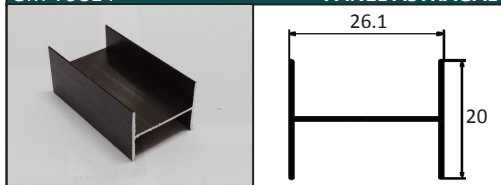

GM-79819 **DOUBLE FLAT SILL**

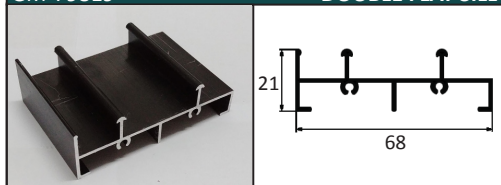

GM-79826 **GLASS DIVIDER**

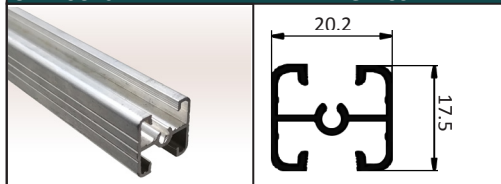

GM-79811 **TRANSOM HEAD**

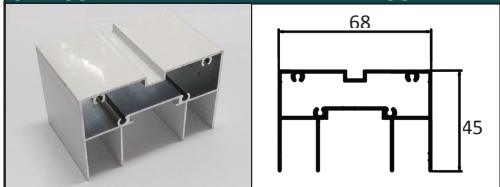

GM-79813 **SCREEN DIVIDER**

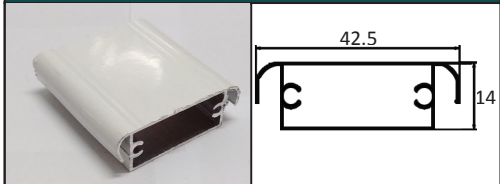

GM-79817 **TRANSOM SILL**

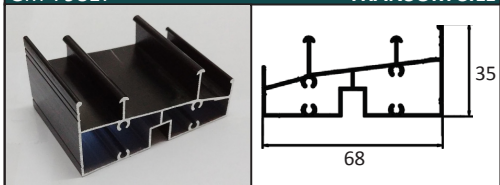

GM-79825 **TRANSOM GLASS DIVIDER**

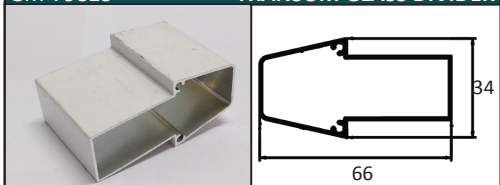

GM-79831 **SCREEN ASTRAGAL**

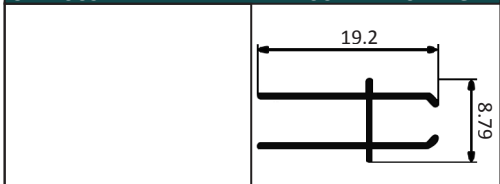

# 1ne Sky

ALUMINUM · STAINLESS · GLASS

铝材 · 不锈钢 · 玻璃

PH Standard 1.0mm thickness

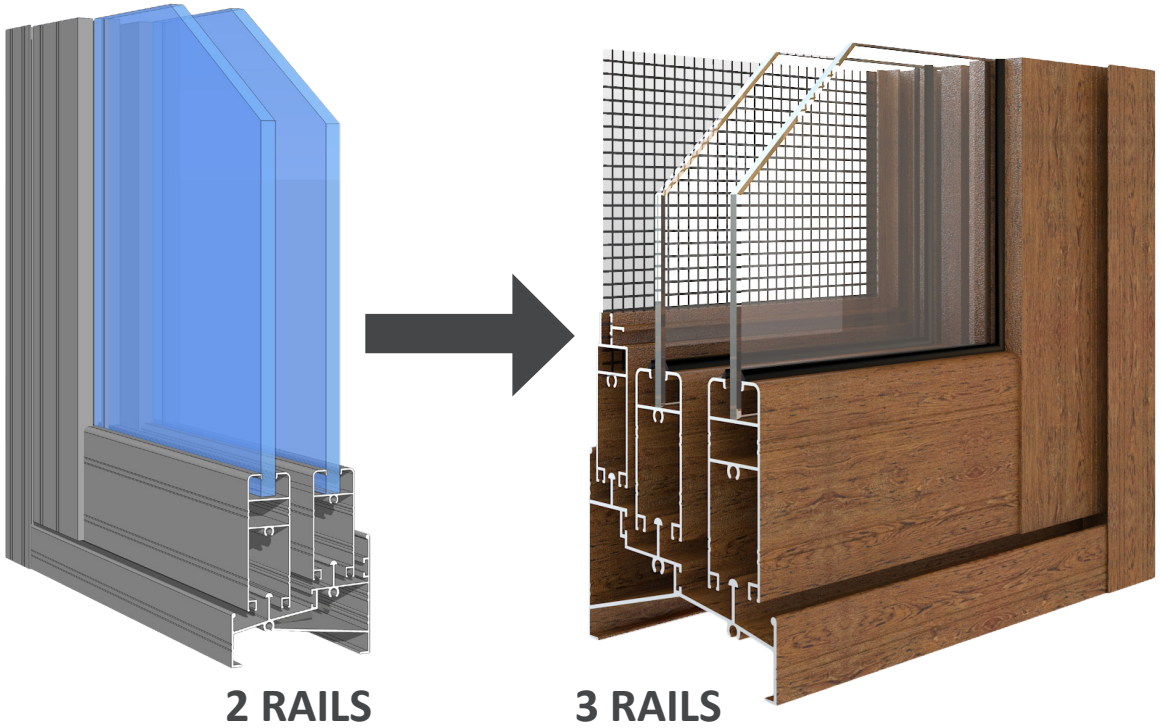

## 900 SERIES (1.2mm)

*Sliding Windows and Doors (Designer Series)*

### Characteristics & Advantages

- Applicable for windows and doors
- Bigger version of 798 Profile
- Bigger and sturdier rollers for bigger panels
- Thicker Aluminum
- Improved security
- Integrated insects screens
- Easy to clean and maintain
- Wide range of colours to suit your interior and exterior designs
- Window glazing for improved energy efficiency
- Top and Bottom plastic guides smooth & quiet sliding motion
- Improved side rail against sudden impact
- Improved double sill-sloping design to assure water flow

**900 PROFILE Accessories**

PH Standard 1.0mm thickness



**900 SERIES PUNCHER**

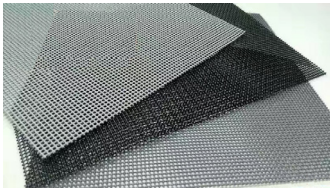

Hardmesh



new screen roller



new screen guide  
top/bottom



900 Panel Roller  
(Single)



900 Blue Nylon  
Roller (Single)



900 Blue Nylon  
Roller (Double)



904 Big Center  
Lock Left/Right



900 Jamb Rubber

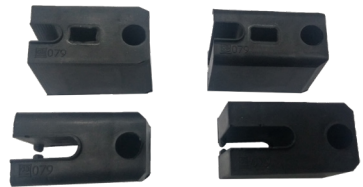

900 Plastic Guide  
4 Kinds



Double Jamb  
Gasket



Durable Flashlock  
w/key



Mohair

**900 PROFILES Sliding Window**

PH Standard 1.0mm thickness

OS-97801 **DOUBLE HEAD (3 Tracks)**

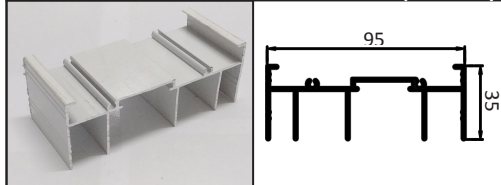

OS-97802 **DOUBLE SILL (3 Tracks)**

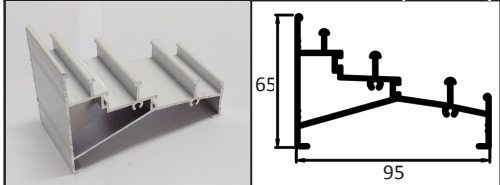

OS-97803 **DOUBLE JAMB (3 Tracks)**

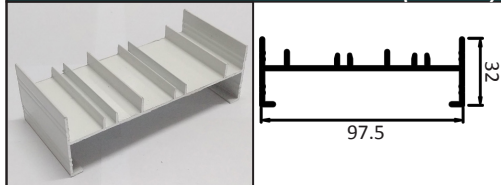

GM-99901 **DOUBLE HEAD**

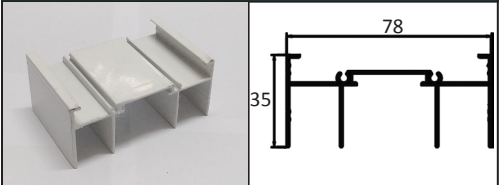

GM-99902 **DOUBLE SILL**

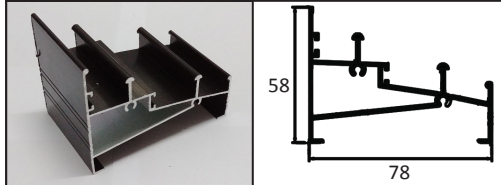

GM-99903 **DOUBLE JAMB**

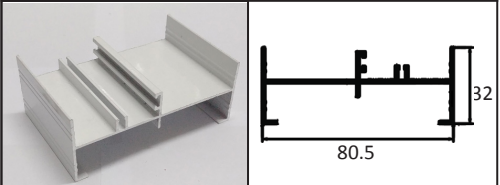

GM-99904 **TOP RAIL**

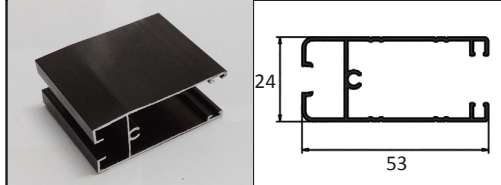

GM-99905 **OUTER BOTTOM RAIL**

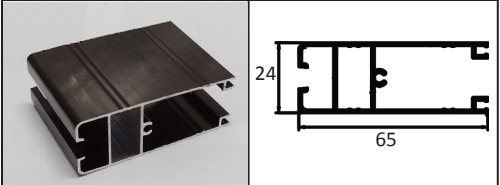

GM-99906 **LOCKSTILE**

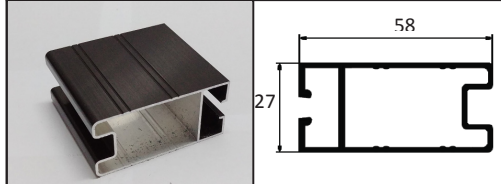

GM-99907 **INTERLOCKER**

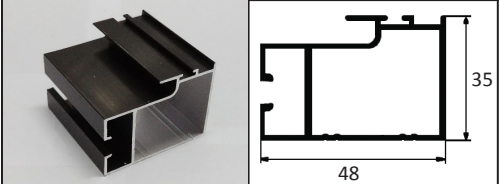

GM-99904A **INNER BOTTOM RAIL**

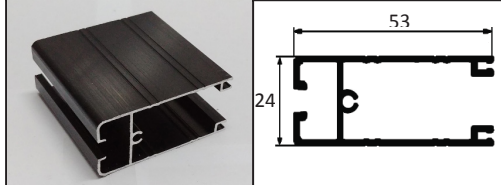

GM-99910 **FIXED HEAD**

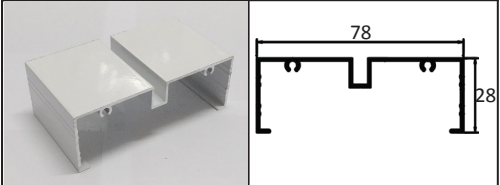

GM-99911 **TRANSOM HEADER**

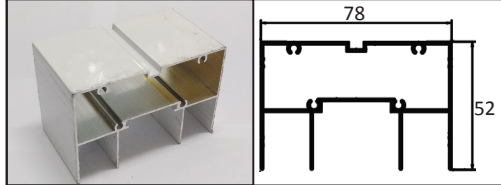

GM-99914 **PANEL ASTRAGAL**

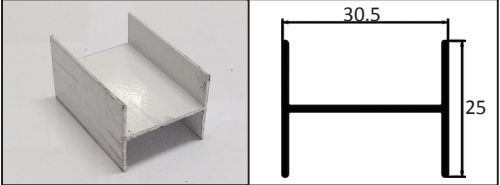

GM-99917 **TRANSOM SILL**

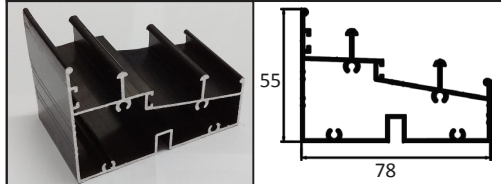

**DOUBLE FLAT SILL/DOUBLE FLAT SILL 3 Tracks**

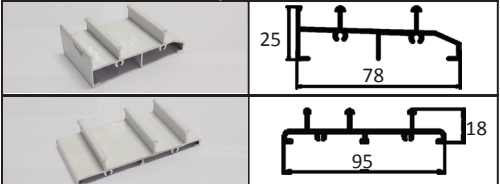

# 1ne Sky

ALUMINUM · STAINLESS · GLASS

铝材 · 不锈钢 · 玻璃

PH Standard 1.0mm thickness

## 38 SERIES (1.0mm)

*Casement & Awning Window  
(Classic Series)*

---

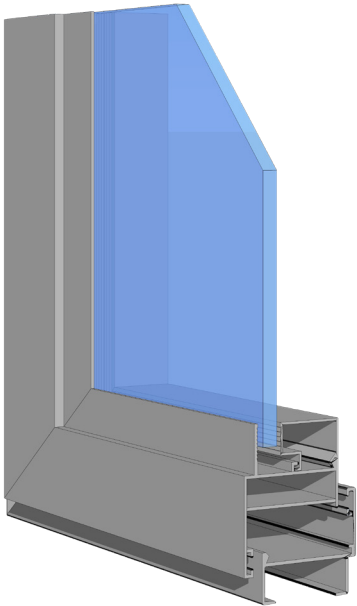
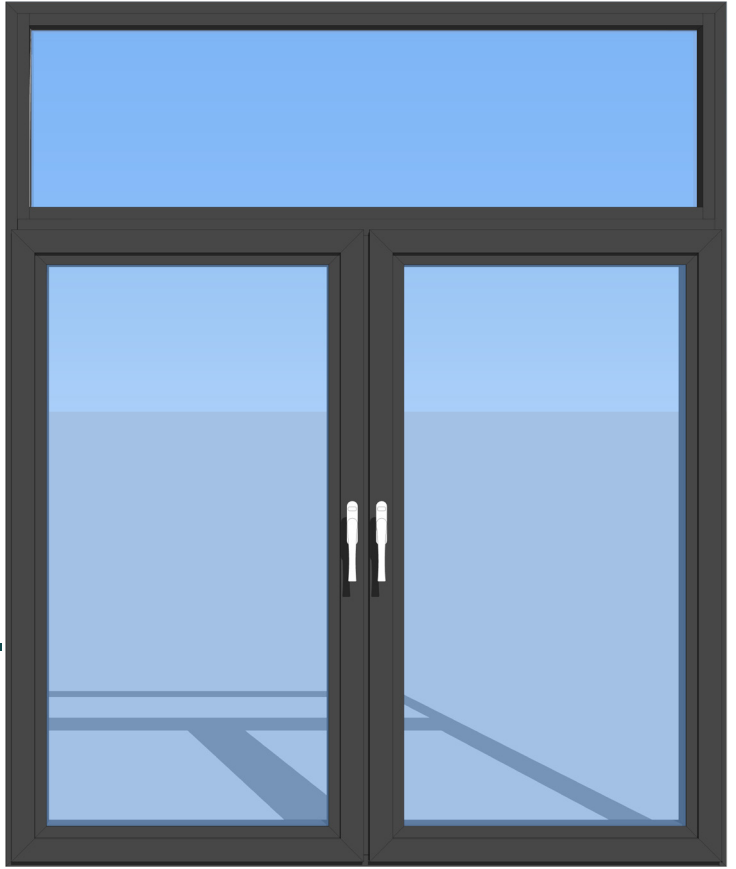

## Characteristics & Advantages

---

- It has 1.0mm thickness and be fitted in all kinds of residential and commercial establishment.
- More budget wise than 50 series
- Partner of 798 Series sliding window

## 38 PROFILES Casement & Awning Window

PH Standard 1.0mm thickness

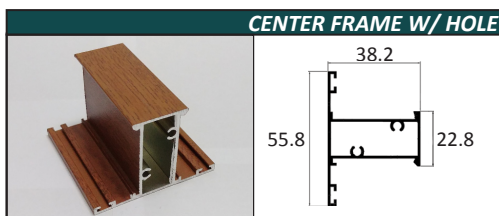
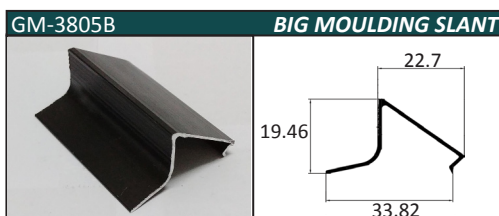
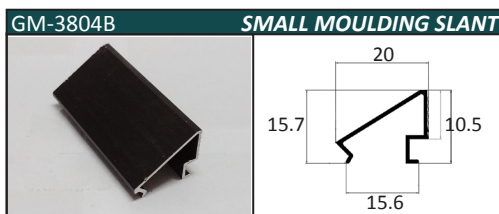
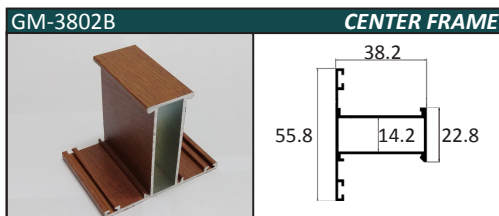
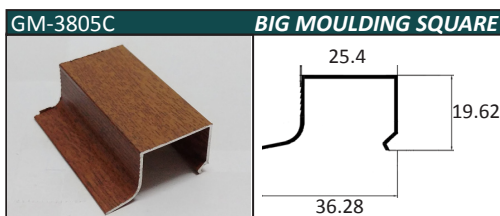
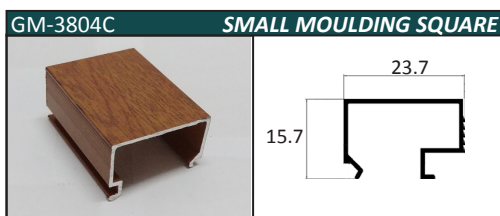
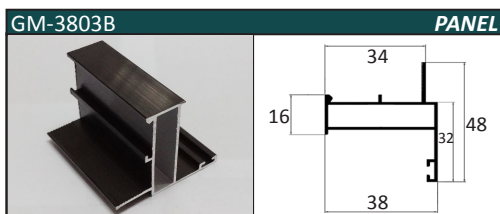
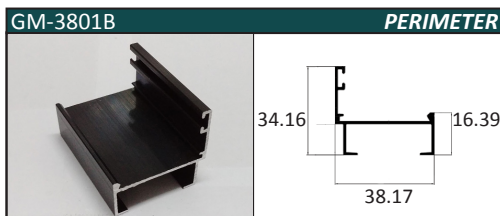

## Accessories



428B Camhandle



368B Camhandle



378A Camhandle



YC 38 Bubble Vinyl



Forebar Center/Side Open  
 (8", 10", 12", 14")  
 202 & 304 stainless steel



802 Durable Camhandle  
 (right/left)

# 1ne Sky

ALUMINUM · STAINLESS · GLASS

铝材 · 不锈钢 · 玻璃

PH Standard 1.0mm thickness

## 50 SERIES (1.2mm)

*Casement & Awning Window  
(Commercial Series)*

---

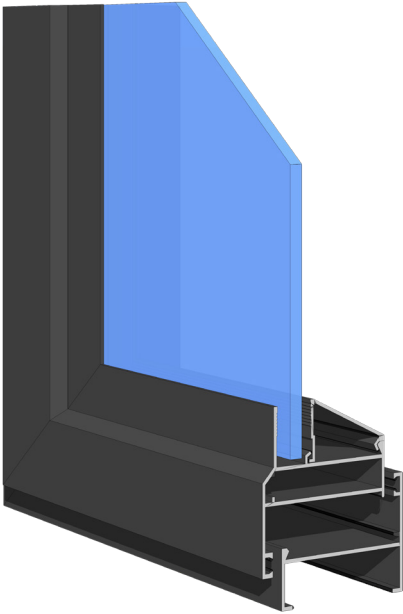
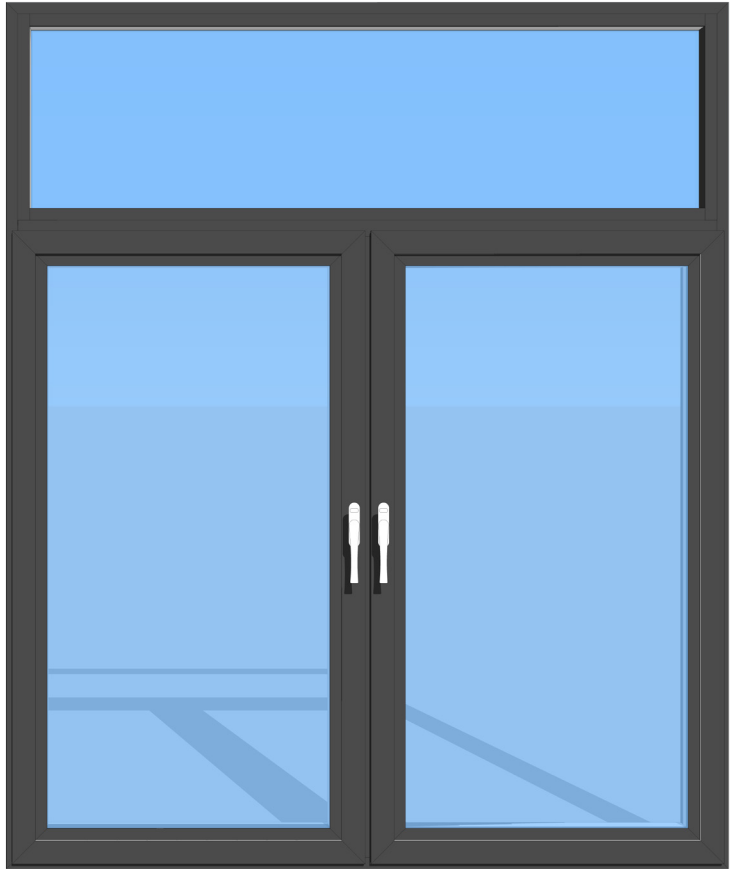

## Application

---

Widely used in residential properties like condominiums, bungalows or villas, schools, hospitals and commercial settings like factories and business buildings. It's adherence to functional and performance requirements to international standards, wide range of applications and cost efficiency makes it an ideal choice in new construction, replacement and remodeling projects.



## 50 PROFILES Casement & Awning Window

PH Standard 1.0mm thickness

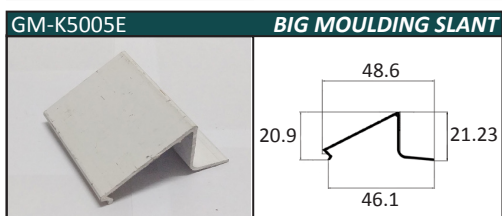
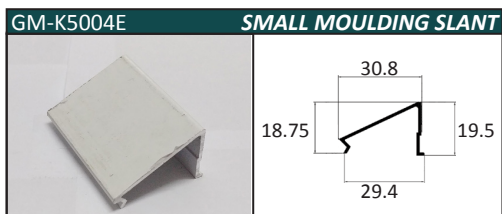
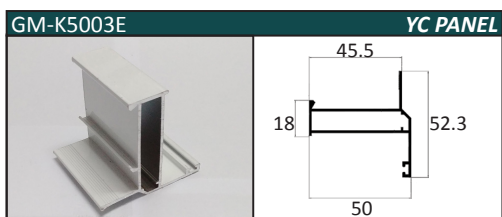
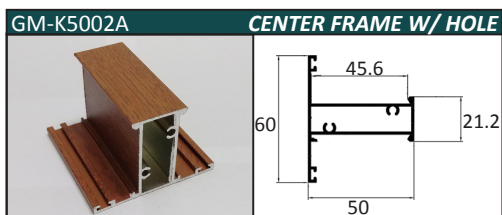
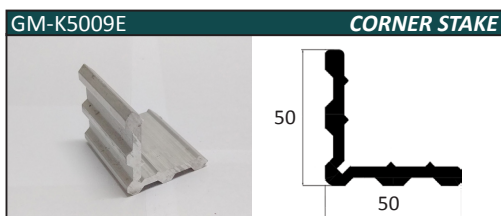
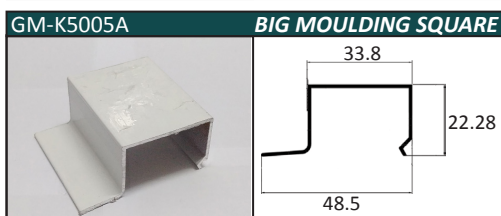
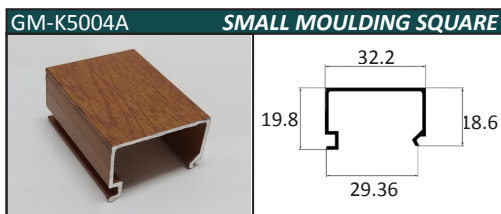
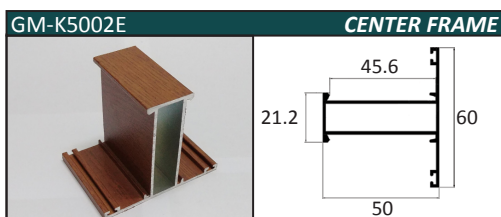
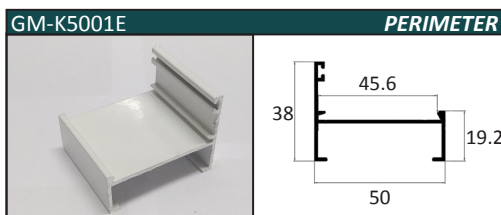

## Accessories



YC 50 Bubble Vinyl



Forebar Center/Side Open  
(10", 12", 14")  
202 & 304 stainless steel



802 Durable Camhandle  
(right/left)



378A Camhandle



019 Multi-Lock Handle w/rod  
(400mm, 600mm, 800mm, 1000mm)

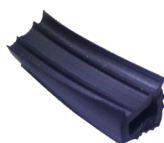

YC 50 Rubber  
Glazing/Square Mould



368B Camhandle



428B Camhandle

**45 Profile (1.4mm)**  
*Highrise Casement Window  
& Swing Door  
(Office & Balcony Design)*

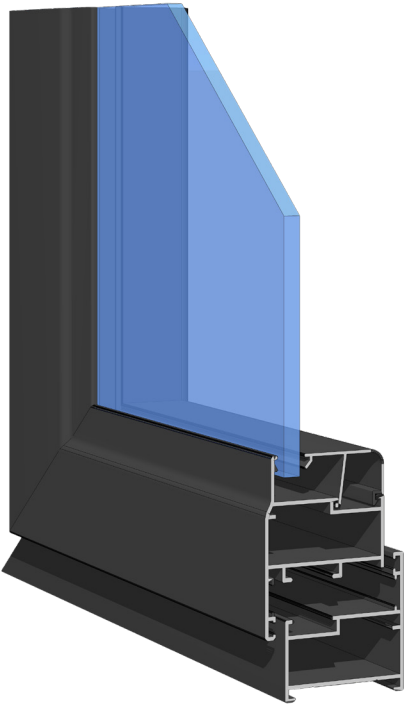
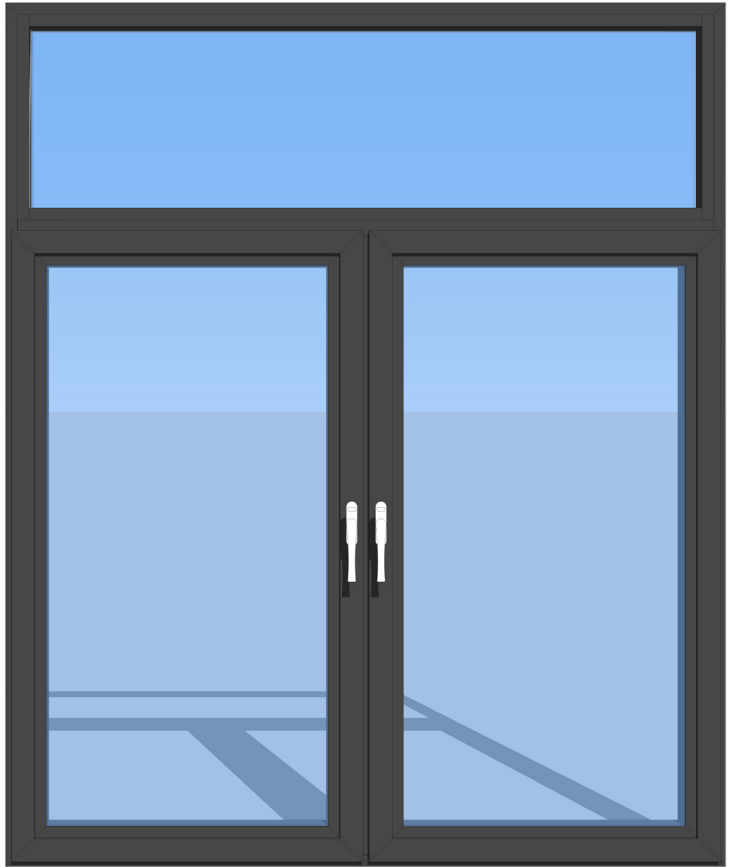

**Characteristics & Advantages**

- Our swing door that can be used in a high-rise residential building.
- It has 1.4 mm thickness that assures the best durable swing door for your home.
- Modern design swing door for your office.
- Also available in processed glass up to 10mm.

## 45 PROFILES Swing door series

PH Standard 1.0mm thickness

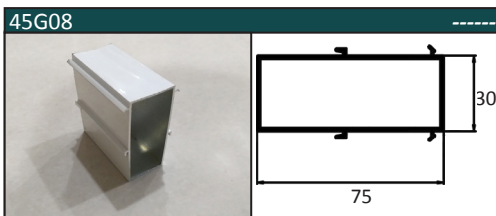
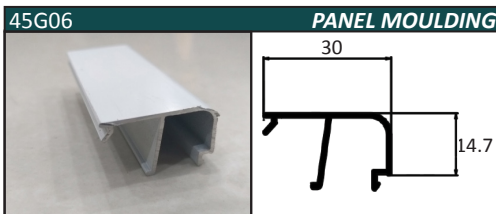
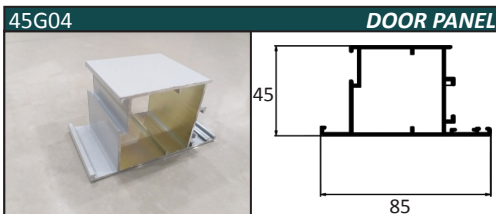
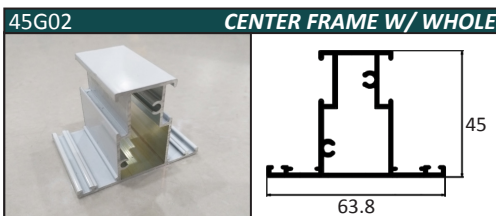
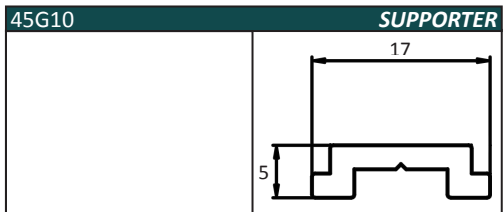
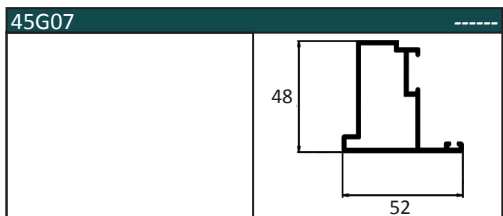
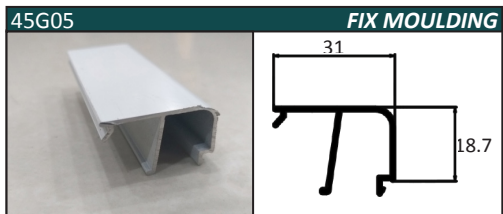
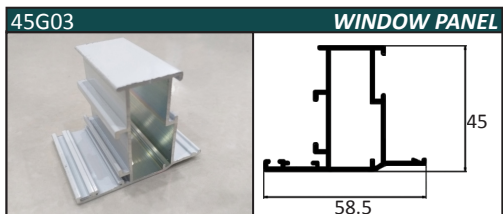
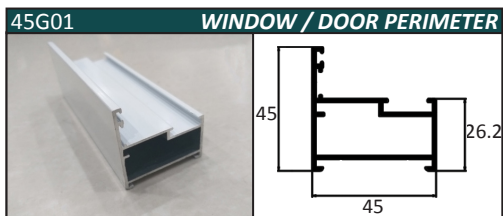

## Accessories



Door handle white



Door handle black



Aluminum Door Hinges



Fore bar 304 (10", 12", 14", 16")

# 1ne Sky

ALUMINUM · STAINLESS · GLASS

铝材 · 不锈钢 · 玻璃

PH Standard 1.0mm thickness



## 75 SERIES

*Swing Door and Office Partition*



## 75 PROFILES Swing Door

PH Standard 1.0mm thickness

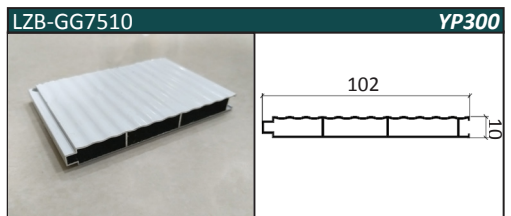
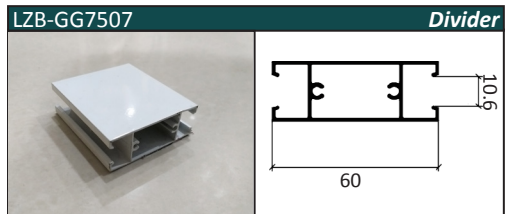
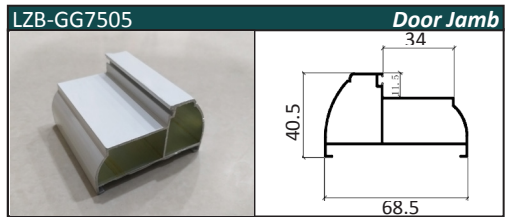
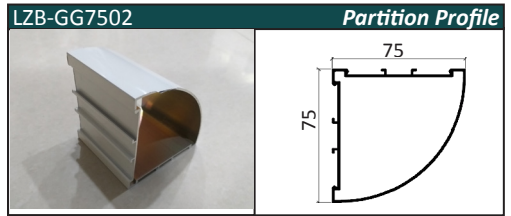
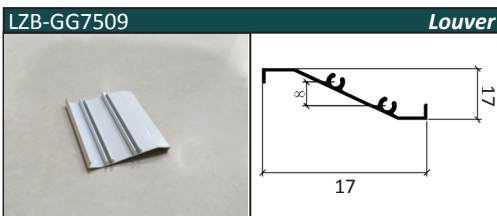
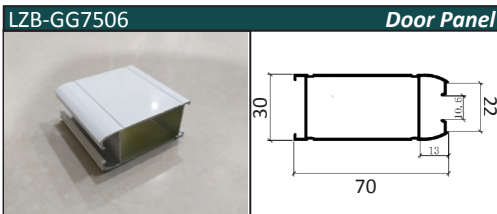
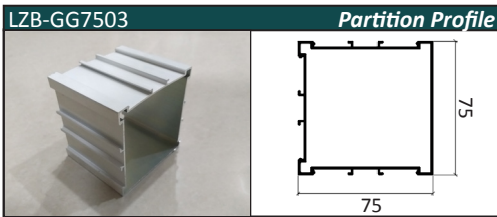
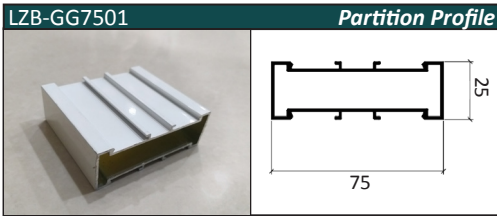

## Accessories



Alum-hinge  
Black/Silver





Door handle



Bracket



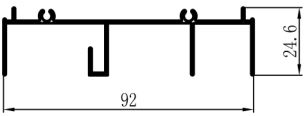
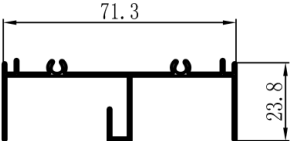
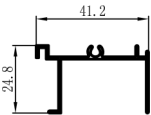
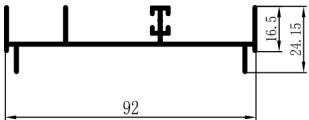
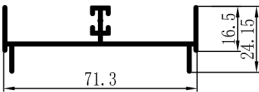
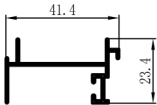

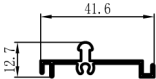
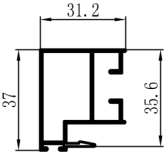
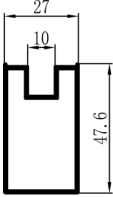
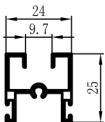
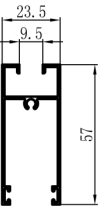
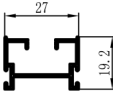
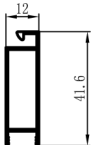
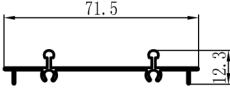
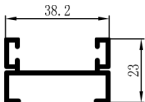
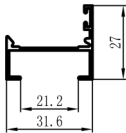
**TRADITIONAL PROFILES**

PH Standard 1.0mm thickness

 <p>(GM-LGY01) <i>Double Head with Screen</i></p>	 <p>(GM-LGY02) <i>Double Head</i></p>	 <p>(GM-LGY03) <i>Single Head</i></p>
 <p>(GM-LGY04) <i>Double Jamb w/ Screen</i></p>	 <p>(GM-LGY05) <i>Double Jamb</i></p>	 <p>(GM-LGY06) <i>Single Jamb</i></p>
 <p>(GM-LGY07) <i>Double Sill w/ Screen</i></p>	 <p>(GM-LGY08) <i>Double Sil</i></p>	 <p>(GM-LGY09) <i>Single Sill</i></p>
 <p>(GM-LGY10) <i>Interlocker</i></p>	 <p>(GM-LGY11) <i>Lockstile</i></p>	 <p>(GM-LGY12) <i>Top rail</i></p>
 <p>(GM-LGY13) <i>Bottom Rail</i></p>	 <p>(GM-LGY14) <i>Fixed Stile</i></p>	 <p>(GM-LGY15) <i>YS 221</i></p>
 <p>(GM-LGY16) <i>Double Flat Sill</i></p>	 <p>(GM-LGY17) <i>Panel Astragal</i></p>	 <p>(GM-LGY18) <i>Perimeter</i></p>

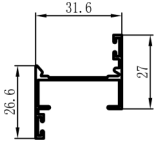
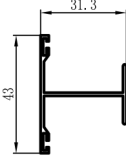
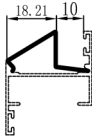
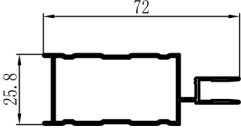
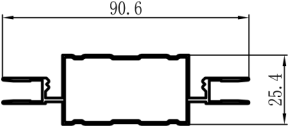
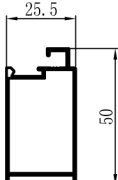
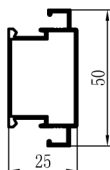
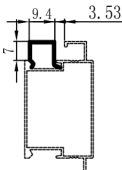
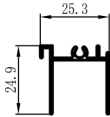
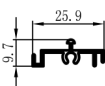
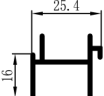

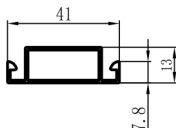
**TRADITIONAL PROFILES**

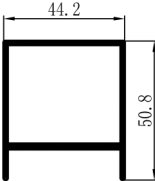
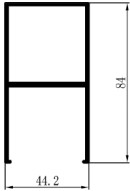
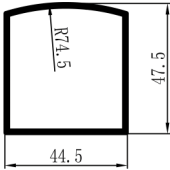
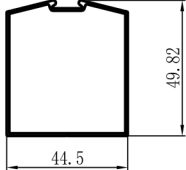
PH Standard 1.0mm thickness

 <p><b>(GM-LGY19)</b> <i>Panel</i></p>	 <p><b>(GM-LGY20)</b> <i>Center Frame</i></p>	 <p><b>(GM-LGY21)</b> <i>Moulding</i></p>
 <p><b>(GM-LGY22)</b> <i>Amplemesh Single</i></p>	 <p><b>(GM-LGY23)</b> <i>Amplemesh Double</i></p>	 <p><b>(GM-LGY24)</b> <i>SF 101</i></p>
 <p><b>(GM-LGY25)</b> <i>SF 106</i></p>	 <p><b>(GM-LGY26)</b> <i>SF 102</i></p>	 <p><b>(GM-LGY27)</b> <i>Screen Head</i></p>
 <p><b>(GM-LGY28)</b> <i>Screen Sill</i></p>	 <p><b>(GM-LGY29)</b> <i>Screen Jamb</i></p>	 <p><b>(GM-LGY30)</b> <i>Screen Astragal</i></p>
 <p><b>(GM-LGY31)</b> <i>Screen Divider</i></p>	 <p><b>(GM-LGY32)</b> <i>ASW Screen Sill</i></p>	 <p><b>(GM-LGY33)</b> <i>ED Top Rail</i></p>
 <p><b>(GM-LGY34)</b> <i>ED Bottom Rail</i></p>	 <p><b>(GM-LGY35)</b> <i>ED Bullnose Stile</i></p>	 <p><b>(GM-LGY36)</b> <i>ED Stile w/ Groove</i></p>

**TRADITIONAL PROFILES**

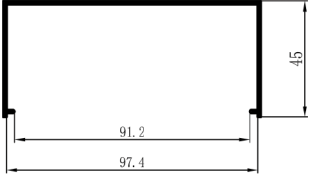
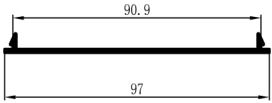
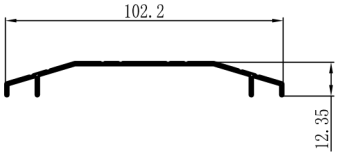
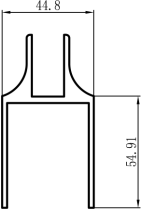
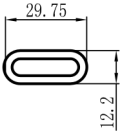
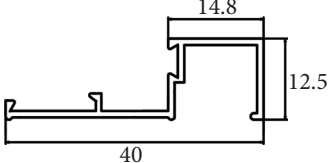
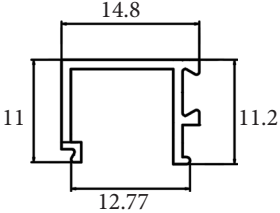
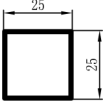
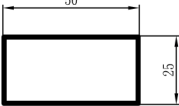
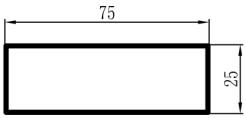
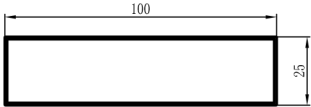
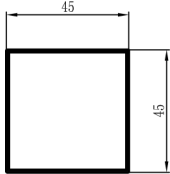
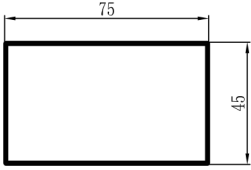
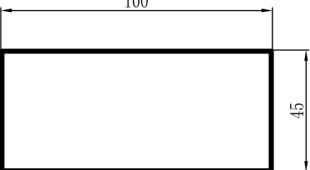
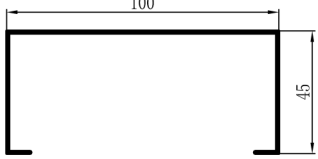
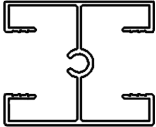
PH Standard 1.0mm thickness

 <p>(GM-LGY37) <i>Split Tube Base</i></p>	 <p>(GM-LGY38) <i>Split Tube Cover</i></p>	 <p>(GM-LGY39) <i>Threshold</i></p>
 <p>(GM-LGY40) <i>FD 100 (2.0mm)</i></p>	 <p>(GM-LGY41) <i>Push Bar Handle</i></p>	 <p>(GM-LGY42) <i>Snap-on Base</i></p>
 <p>(GM-LGY43) <i>Snap-on Cover</i></p>	 <p>(GM-LGY44) <i>Tubular 1x1</i></p>	 <p>(GM-LGY45) <i>Tubular 1x2</i></p>
 <p>(GM-LGY46) <i>Tubular 1x3</i></p>	 <p>(GM-LGY47) <i>Tubular 1x4</i></p>	 <p>(GM-LGY48) <i>Tubular 1 3/4 x 1 3/4</i></p>
 <p>(GM-LGY49) <i>Tubular 1 3/4 x 3</i></p>	 <p>(GM-LGY50) <i>Tubular 1 3/4 x 4</i></p>	 <p>(GM-LGY51) <i>Open Back 1 3/4 x 4</i></p>
 <p>(GM-LGY55) <i>Glass Divider</i></p>	 <p>(GM-LGY56) <i>Bus Body</i></p>	 <p>(GM-LGY57) <i>Swing Screen Bumper</i></p>



**TRADITIONAL PROFILES**

PH Standard 1.0mm thickness

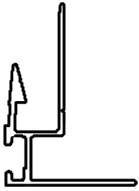
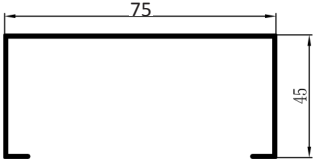
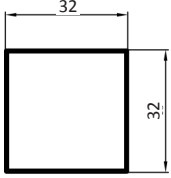
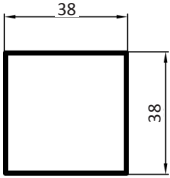
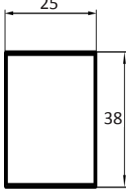
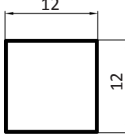
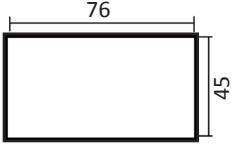
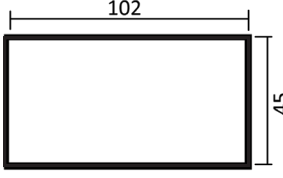
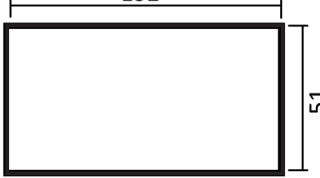
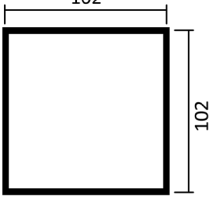
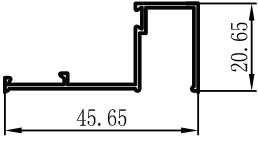
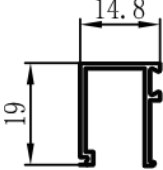
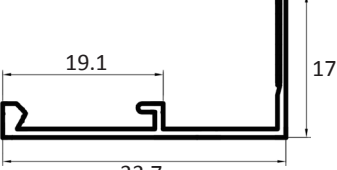
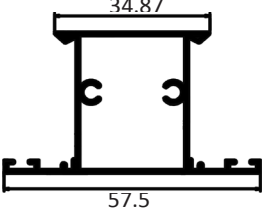
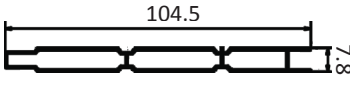
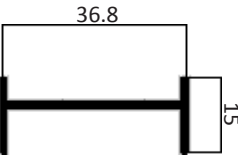
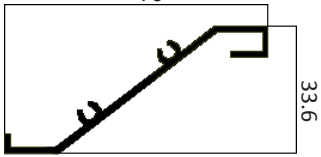
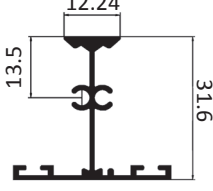
 <p><b>(GM-LGY58)</b> <i>Fixed Interlocker</i></p>	 <p><b>(GM-LGY62)</b> <i>Open Back 1 3/4 x 3</i></p>	 <p><b>(GM-F32x32)</b> <i>Tubular 1 1/4 x 1 1/4</i></p>
 <p><b>(GM-F38x38)</b> <i>Tubular 1 1/2 x 1 1/2</i></p>	 <p><b>(GM-F38x25)</b> <i>Tubular 1 1/2 x 1</i></p>	 <p><b>(GM-)</b> <i>Tubular 1/2 x 1/2</i></p>
 <p><b>(GM-F45x76)</b> <i>Tubular 1 3/4 x 3 (2.0mm)</i></p>	 <p><b>(GM-F45x102)</b> <i>Tubular 1 3/4 x 4 (2.0mm)</i></p>	 <p><b>(GM-F150x50)</b> <i>Tubular 2 x 6 (2.0mm)</i></p>
 <p><b>(GM-F100x100)</b> <i>Tubular 4 x 4 (2.0mm)</i></p>	 <p><b>(GM-LGY79)</b> <i>Big SOB</i></p>	 <p><b>(GM-LGY80)</b> <i>Big SOC</i></p>
 <p><b>(GM-YZ04)</b> <i>Slant SOBC</i></p>	 <p><b>(GM-LGY72)</b> <i>YC Mullion</i></p>	 <p><b>(GM-LGY96)</b> <i>YP200</i></p>
 <p><b>(GM-BY01)</b> <i>Louver Frame (1.4mm)</i></p>	 <p><b>(GM-BY02)</b> <i>Louver Blade (1.4mm)</i></p>	 <p><b>(GM-LGY71)</b> <i>Center Frame w/hole</i></p>





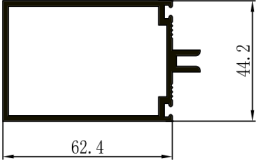
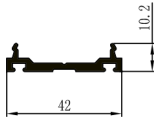
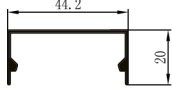
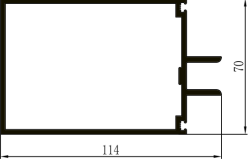
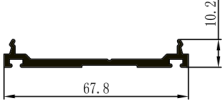
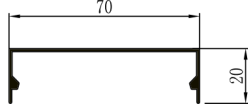
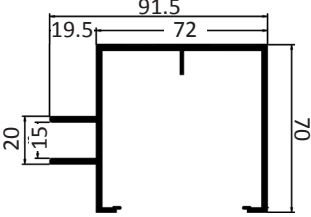
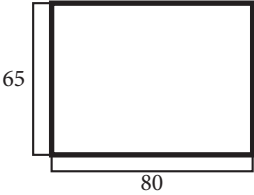
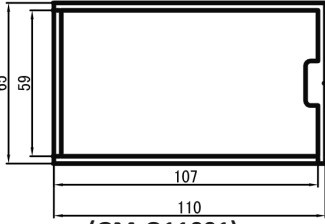
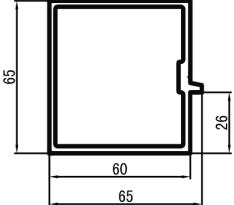
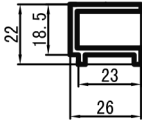
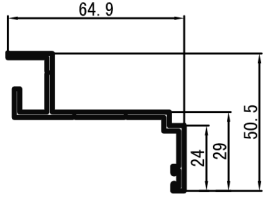
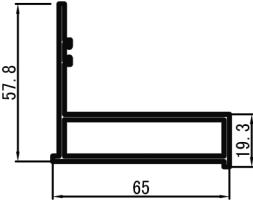
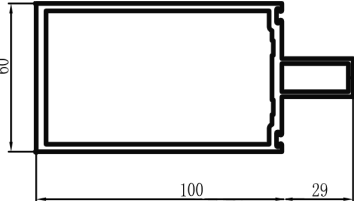
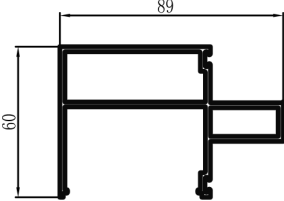
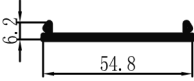
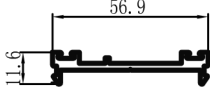
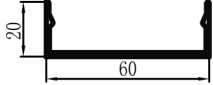

**MULLION SERIES**

PH Standard 1.0mm thickness

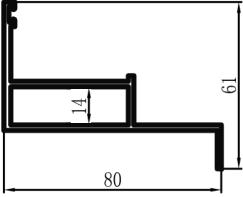
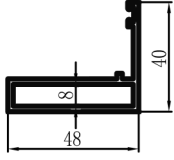
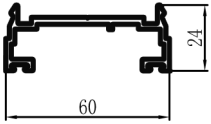
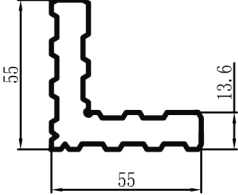
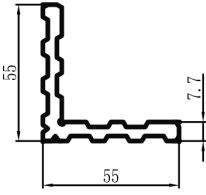
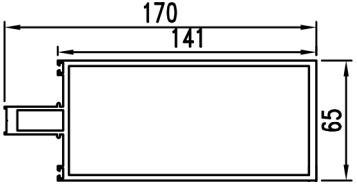
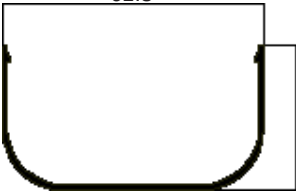
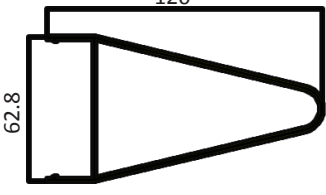
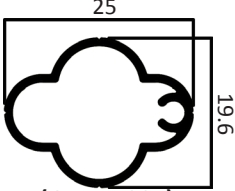
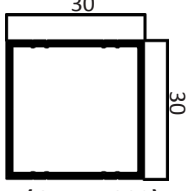
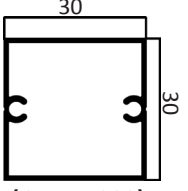
 <p>(GM-LGY73) Small Mullion</p>	 <p>(GM-LGY74) Small Mullion (Base)</p>	 <p>(GM-LGY75) Small Mullion (Cover)</p>
 <p>(GM-LGY76) Big Mullion</p>	 <p>(GM-LGY77) Big Mullion (Base)</p>	 <p>(GM-LGY78) Big Mullion (Cover)</p>
 <p>(GM-LGY103) Split Mullion</p>	 <p>(GM-F65x80) Mini Seamless (2.0mm)</p>	 <p>(GM-Q11001) 110 seamless mullion (3.0mm)</p>
 <p>(GM-Q11003) 110 split seamless (2.5mm)</p>	 <p>(GM-Q11004) (2.5mm)</p>	 <p>(GM-Q11007) 110 Mullion Perimeter (2.0mm)</p>
 <p>(GM-Q11008) 110 Mullion Panel (2.0mm)</p>	 <p>(GM-MQ13001) 130 Mullion (3.0mm)</p>	 <p>(GM-MQ13003) 130 Split Mullion (2.0mm)</p>
 <p>(GM-MQ13004) 130 Split Mullion Cover (1.6mm)</p>	 <p>(GM-MQ13005) 130 Mullion Base (2.5mm)</p>	 <p>(GM-MQ13006) 130 Mullion Cover (1.2mm)</p>

**MULLION SERIES**

PH Standard 1.0mm thickness

 <p>(GM-MQ13007) <b>130 Mullion Perimeter (2.0mm)</b></p>	 <p>(GM-MQ13008) <b>130 Mullion Panel (2.0mm)</b></p>	 <p>(GM-MQ13012) <b>Single Glaze Adaptor (2.0mm)</b></p>
 <p>(GM-MQ13031) <b>Perimeter Bracket</b></p>	 <p>(GM-MQ13030) <b>Panel Bracket</b></p>	 <p>(GM-LGY102) <b>170 Mullion</b></p>
 <p>(GM-MQ14006) <b>Mullion Cover</b></p>	 <p>(GM-MQ14009) <b>Mullion Cover</b></p>	
<b>GRILL DESIGNS</b>		
 <p>(GM-FD001) <b>Flower Tube</b></p>	 <p>(GM-FD002) <b>Tubular Frame</b></p>	 <p>(GM-FD009) <b>Tubular Divider</b></p>
<b>SECONDARY SECTIONS</b>		
 <p><math>1/2 \times 1/2</math>     <math>1/2 \times 2</math> <math>1/2 \times 1</math>     <math>1/2 \times 3</math> <math>1/2 \times 1-1/2</math>     <math>1/2 \times 4</math></p> <p><b>Counter Trim</b></p>	 <p><math>1/2 \times 1/2</math>     <math>1 \times 1</math> <math>1/2 \times 1</math>     <math>1-1/2 \times 1-1/2</math> <math>3/4 \times 3/4</math>     <math>2 \times 2</math> <math>3/4 \times 1</math></p> <p><b>Angular</b></p>	 <p><math>1/2 \times 1/2</math> <math>3/4 \times 3/4</math> <math>1/2 \times 3/4</math></p> <p><b>U-Channel</b></p>
 <p><math>3/8''</math>     <math>3/4''</math> <math>1/2''</math>     <math>1''</math></p> <p><b>Round Tube</b></p>	 <p><math>1/2''</math> <math>1/4''</math></p> <p><b>J-Clip</b></p>	 <p><math>1/8 \times 1-1/2</math>     <math>1/8 \times 3/4</math> <math>1/8 \times 1</math>     <math>1/8 \times 1/2</math></p> <p><b>Flat Bars</b></p>

**TRADITIONAL SERIES Accessories**

**PH Standard 1.0mm thickness**

<p>#01</p>  <p>SD Roller Matex</p>	<p>#02</p>  <p>SD Roller with bearing</p>	<p>#03</p>  <p>Screen Roller 221</p>	<p>#04</p>  <p>Screen tension roller</p>
<p>#05</p>  <p>Steel roller single</p>	<p>#06</p>  <p>SD roller black single</p>	<p>#07</p>  <p>SD roller black double</p>	<p>#08</p>  <p>SD Roller double</p>
<p>#09</p>  <p>HT roller</p>	<p>#10</p>  <p>ASW mini roller</p>	<p>#11</p>  <p>Topside</p>	<p>#12</p>  <p>Bended Handle</p>
<p>#13 #14</p>  <p>Corner bracket (Aluminum, Plastic)</p>	<p>#15</p>  <p>Flushlock #12-13</p>	<p>#16</p>  <p>Flushlock #12 Alum / Zinc</p>	<p>#17</p>  <p>Flushlock #11</p>
<p>#18</p>  <p>Autolock</p>	<p>#19</p>  <p>Flushlock #10</p>	<p>#20</p>  <p>Durable flushlock</p>	<p>#21</p>  <p>WF lockset</p>

**TRADITIONAL SERIES Accessories**

PH Standard 1.0mm thickness

<p>#22</p>  <p>Flushbolt</p>	<p>#23</p>  <p>New flushlock</p>	<p>#24</p>  <p>Pneumatic Door Closer</p>	<p>#25</p>  <p>Arm-Type Door Closer</p>
<p>#26</p>  <p>Samson Handle</p>	<p>#27</p>  <p>Alpha lock</p>	<p>#28</p>  <p>Bus Balancer</p>	<p>#29</p>  <p>Magnetic Single</p>
<p>#30</p>  <p>Magnetic Double</p>	<p>#31</p>  <p>Spline roller</p>	<p>#32</p>  <p>K-star glass cutter</p>	<p>#33</p>  <p>Plastic Cap</p>
<p>#34</p>  <p>Screen Handle (White /Black)</p>	<p>#35</p>  <p>Steel Hinge</p>	<p>#36</p>  <p>New alum-hinge (Screen door)</p>	<p>#37</p>  <p>Barrel bolt</p>
<p>#38 (4-2) #39 (4-4) #40 (4-6)</p>  <p>Blind Rivets (4-2, 4-4, 4-6) (Anodize/Analok)</p>	<p>#41</p>  <p>FD Cover</p>	<p>#42</p>  <p>Grinding stone</p>	<p>#43 (5) #44 (8)</p>  <p>Tox 5 &amp; 8</p>













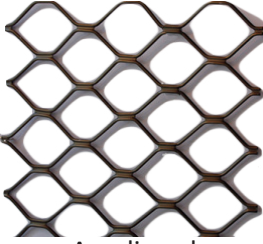

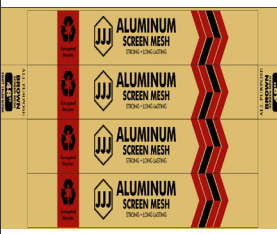



**TRADITIONAL SERIES Accessories**

**PH Standard 1.0mm thickness**

<p>#45 - 1" #46 - 1 1/2"</p>  <p>Screw Cap 1" &amp; 1 1/2"</p>	<p>#47</p>  <p>Metal Screw (6x1/2, 6x3/4, 6x1, 8x1/2, 8x3/4, 8x1, 8x1-1/2, 8x2) (Anodize/Analok)</p>	<p>#48</p>  <p>Half moon lock</p>	<p>#49 - 814 BR #50 - 814 BL #51 - 814 WR #52 - 814 WL</p>  <p>YC Cam handle</p>
<p>#53</p>  <p>Luxury Handle</p>	<p>#54</p>  <p>907 center lock</p>	<p>#55</p>  <p>805 cam handle</p>	<p>#56</p>  <p>018 multi lock</p>
<p>#57</p>  <p>Center lock</p>	<p>#58</p>  <p>Push Bar bracket</p>	<p>#59</p>  <p>Glass Socket</p>	<p>#60</p>  <p>H-Type Handle (60cm,100cm,120cm, 150cm,180cm,200cm)</p>
<p>#61</p>  <p>Sealant Gun</p>	<p>#62</p>  <p>Silicon Structural Weatherproofing Sealant</p>	<p>#63</p>  <p>Mirror Mastic</p>	<p>#64 #65</p>  <p>Dow Corning GP/RED</p>
<p>#66</p>  <p>DERFOE <b>Glass Sealant</b> 100% Silicone polymer from U.S.A Dow Corning Door &amp; Windows Installation Silicone Glazing Building Sealant ACETIC Door &amp; Windows Installation NET:300ml</p>	<p>#67</p>  <p>DERFOE <b>GP</b> General Purpose 100% Silicone polymer from U.S.A Dow Corning NET:280mL ACETIC Door &amp; Windows Installation Silicone Glazing Building Sealant</p>	<p>#68</p>  <p>Jalouplus</p>	<p>#69</p>  <p>Drill Bit (2.5, 3, 3.2, 3.5, 4, 4.2, 4.5, 5, 5.2, 5.5)</p>

**TRADITIONAL SERIES Accessories**

PH Standard 1.0mm thickness

<p>#70</p>  <p>Channel Glazing</p>	<p>#71</p>  <p>YC Vinyl</p>	<p>#72 (36) #73 (48)</p>  <p>Expanded Wire (36"/48")(Length: 60ft)</p>	<p>#74 (3x12) #75 (3x14)</p>  <p>Amplimesh (3x14, 3x12)</p>
<p>#76</p>  <p>Stucco 3x9</p>	<p>#77 (36) #78 (48)</p>  <p>Alum Screen Mesh (36"/48")(Length: 100ft)</p>	<p>#79</p>  <p>SD Mohair 500m</p>	<p>#80</p>  <p>ED Mohair 200m</p>
<p>#81</p>  <p>Plastic clip</p>	<p>#82</p>  <p>Plastic cork</p>	<p>#83</p>  <p>Plastic rod</p>	<p>#84</p>  <p>Upper guide</p>
<p>#85</p>  <p>Plastic roller</p>	<p>#86 (50) #87 (38)</p>  <p>Corner stake (50/38)</p>	<p>#88</p>  <p>Overhead Door Closer</p>	<p>#89</p>  <p>Floor Hinge N818 (115kg)</p>
<p>#90</p>  <p>Floor Hinge 220 (100kg)</p>	<p>#91</p>  <p>(304) Top Patch</p>	<p>#92</p>  <p>(304) Bottom Patch</p>	<p>#93</p>  <p>(304) Patchlock</p>

# ①ne Sky

**ALUMINUM - STAINLESS - GLASS**

铝材 、 不锈钢 、 玻璃



Authorized Dealer

